

ALL-NEW 2018 ACCENT



ACCENT

November 21, 2017
SAMA Luncheon

HYUNDAI GLOBAL CONTRIBUTION

A light gray world map is visible in the background of the top section of the slide.

190 Countries

5 Million Units

A light gray world map is visible in the background of the middle section of the slide. Labels for 'Middle East', 'Asia & Pacific', 'North America', and 'Africa' are visible on the map.

In The U.S. More Than 30 Years

ACCENT SALES HISTORY – LAUNCHED IN 1994

Total Sales Since 1994

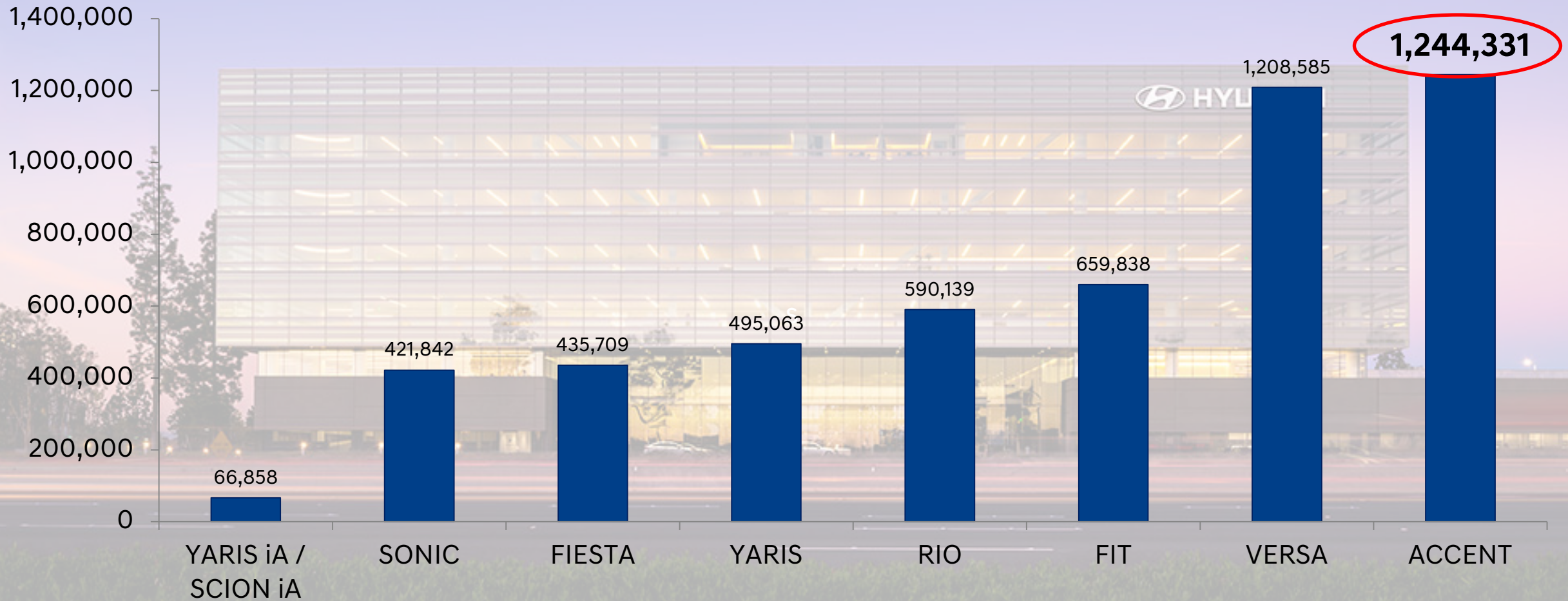

HISPANIC ACCENT OWNERS

Accent Hispanic Share

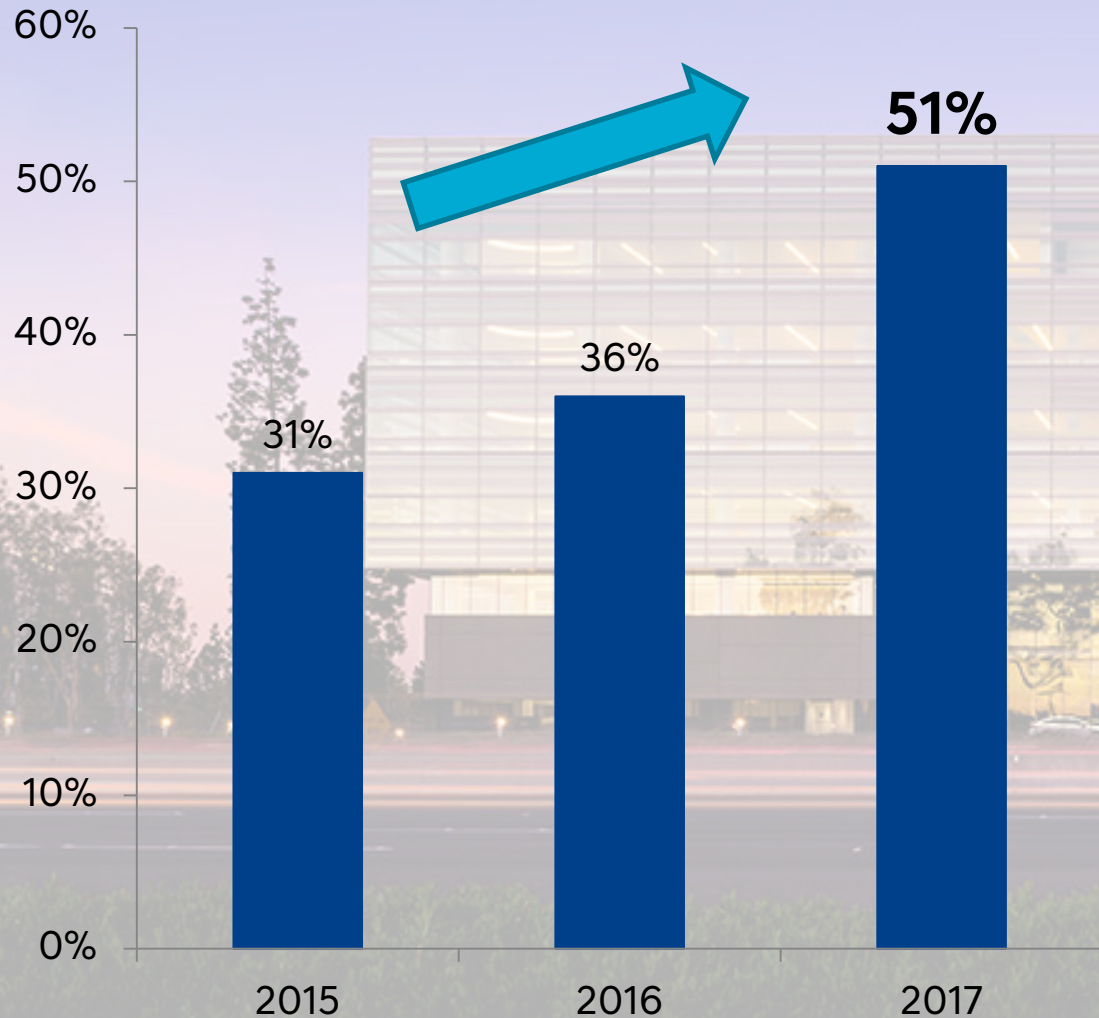

Subcompact Hispanic Share

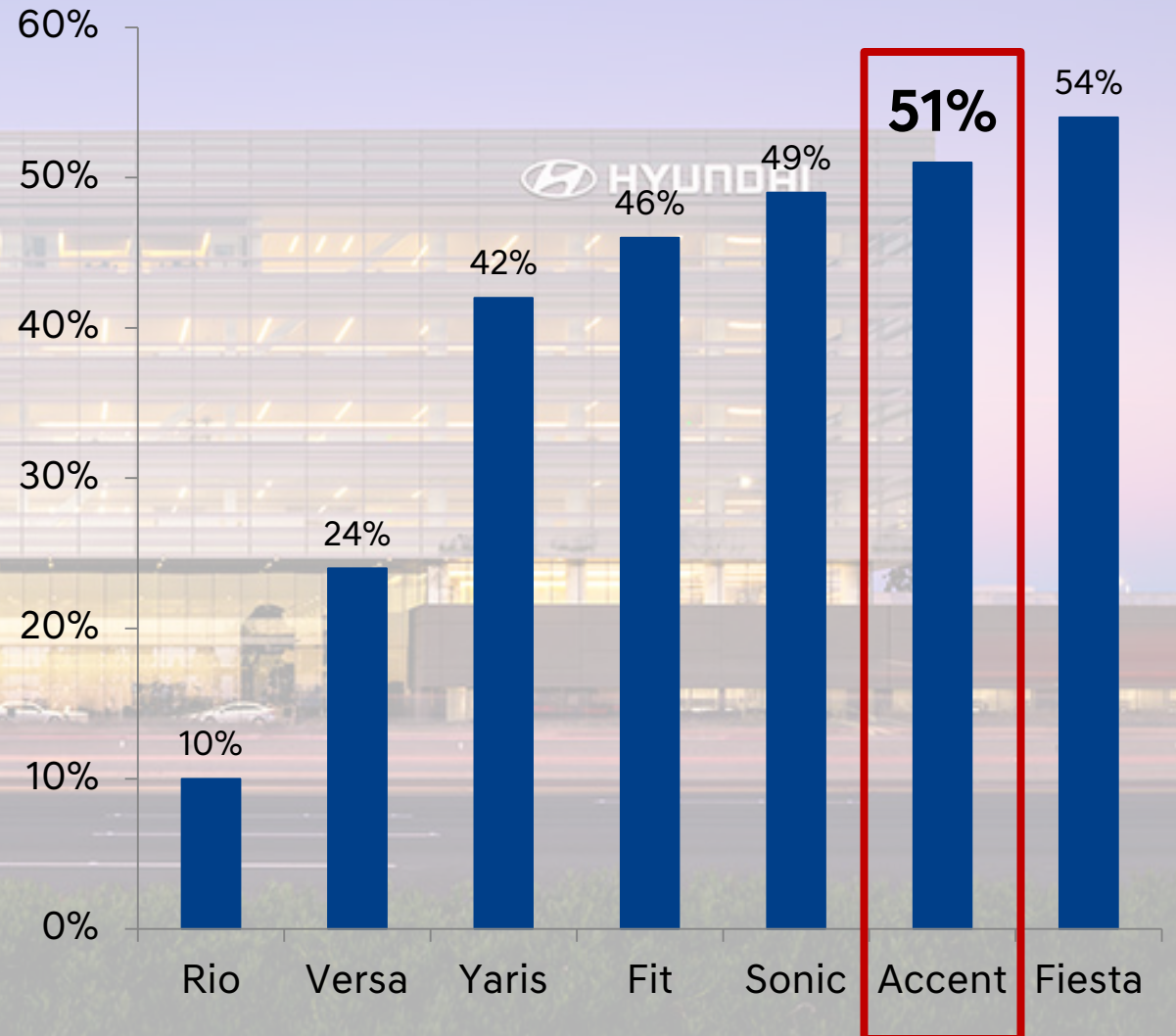

ALL-NEW 2018 ACCENT



ACCENT

NEW CASCADING GRILLE DESIGN

Projector headlights with LED
Daytime Running Lights

Fog lights

Functional air curtains



SIGNATURE DAYLIGHT OPENING

Chrome beltline molding

Side mirror turn signal indicators

17-inch alloys



IMAGE OF STABILITY AND WIDTH

Aerodynamic rear
decklid

Rearview camera

LED taillights



CONTEMPORARY & INTUITIVE INTERIOR DESIGN



WELL-EQUIPPED STANDARD FEATURES

5" Color Touchscreen



Rearview Camera

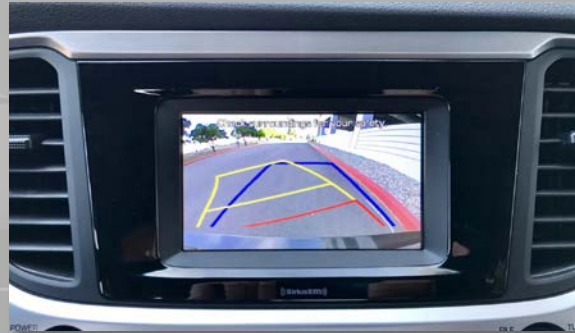

60/40 Split Folding
Rear Seats



Bluetooth
Hands-free Phone



Steering Wheel Audio &
Cruise Controls



GENEROUS SEGMENT-ABOVE SPECIFICATIONS

Proximity Key with Push Button Start



Hands-free Smart Trunk



Automatic Temperature Control



3.5" Monochromatic TFT Display



3-Stage Heated Front Seats



NEW AVAILABLE INFOTAINMENT / SAFETY FEATURES

Dual Charging USB



7" Display Audio



Android Auto & Apple CarPlay



Forward Collision-avoidance Assist



Blue Link Connected Car



HYUNDAI BLUELINK CONNECTED CAR SYSTEM

Available Remote Services via Smartphone, Wearables and Smart Speakers

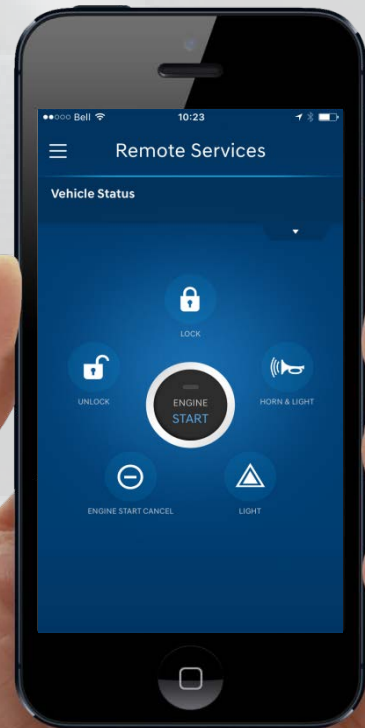

LARGER THAN PREVIOUS GENERATION



| Inches | 2017 ACCENT | DIFFERENCE | 2018 ACCENT |
|-----------|-------------|------------|-------------|
| LENGTH | 172.0 | +0.6 | 172.6 |
| WIDTH | 66.9 | +1.2 | 68.1 |
| HEIGHT | 57.1 | - | 57.1 |
| WHEELBASE | 101.2 | +0.4 | 101.6 |

LARGER THAN FIESTA & YARIS iA

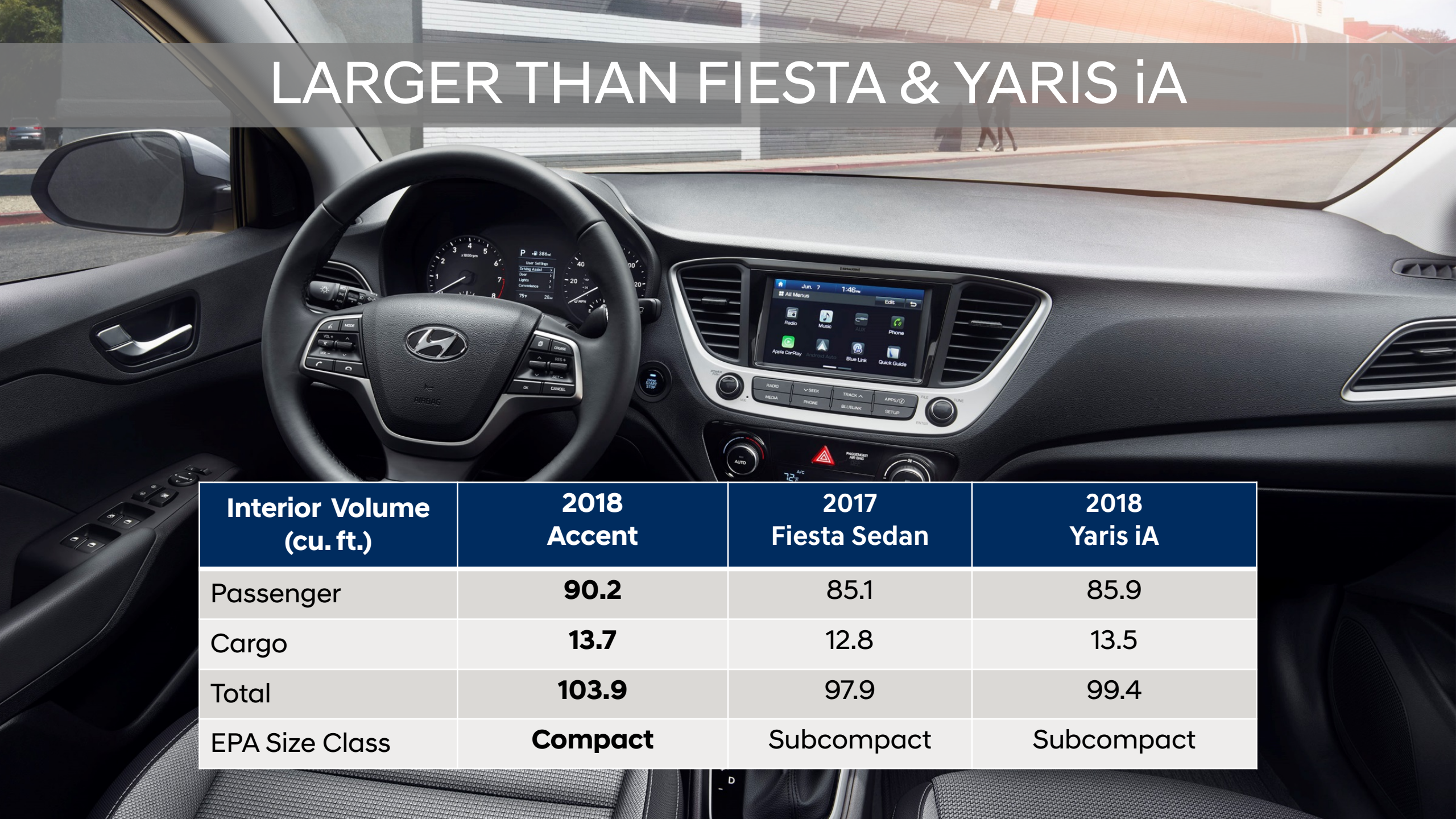
The background image shows the interior of a car, focusing on the dashboard and steering wheel. The steering wheel has the Hyundai logo and 'AIRBAG' text. The dashboard features a central infotainment screen displaying 'Jun. 7 1:45 PM' and various icons for Radio, Music, Phone, and Apple CarPlay. Below the screen are physical buttons for Radio, Media, Phone, and Blue Link. The instrument cluster shows a tachometer and speedometer.

| Interior Volume (cu. ft.) | 2018 Accent | 2017 Fiesta Sedan | 2018 Yaris iA |
|---------------------------|----------------|-------------------|---------------|
| Passenger | 90.2 | 85.1 | 85.9 |
| Cargo | 13.7 | 12.8 | 13.5 |
| Total | 103.9 | 97.9 | 99.4 |
| EPA Size Class | Compact | Subcompact | Subcompact |

POWERTRAIN



- **Gamma 1.6L 4-cylinder engine**
- **Gasoline Direct Injection (GDI)**
- **130 hp & 119 lb.-ft. torque**
- **Estimated 32 Combined MPG**



➤ **+6.6% combined from 2017 model year**

| | Accent | Versa | Fit | Yaris iA | Fiesta | Sonic |
|----|---------------|--------------|------------|-----------------|---------------|--------------|
| HP | 130 | 109 | 130 | 106 | 120 | 138 |

ADVANCED HIGH-STRENGTH STEEL

Steel Type

**Advanced High-strength Steel
> 60kg/mm²**

54.5% Application

28.7 Point increase

— Mild Steel
— 35K ~
— 60K ~
— 100K ~
— 150K

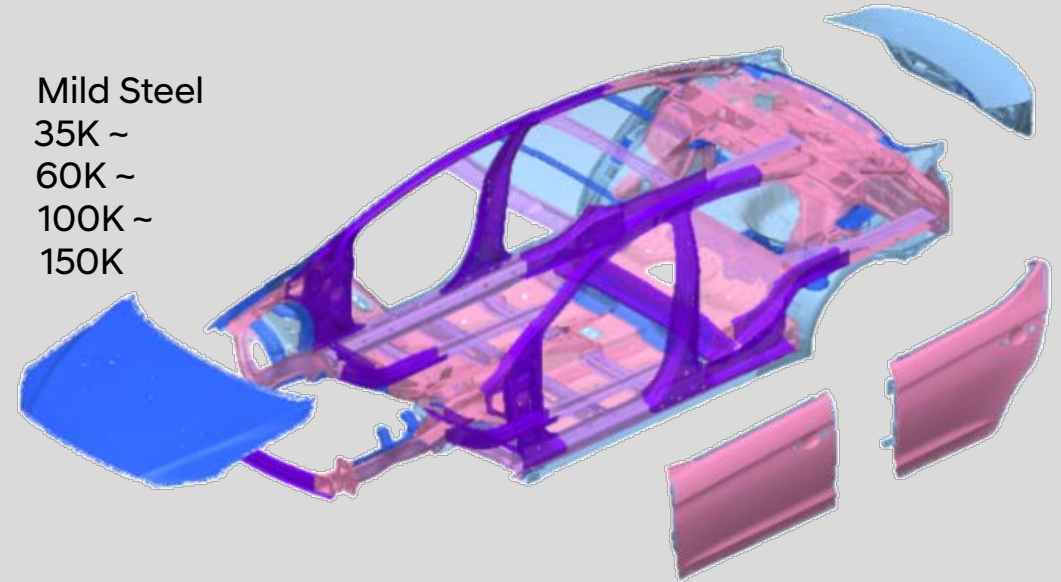

- Improved noise isolation
- Better overall driving dynamics and handling
- Improved collision energy management

RIDE AND HANDLING

Torque Vectoring Control

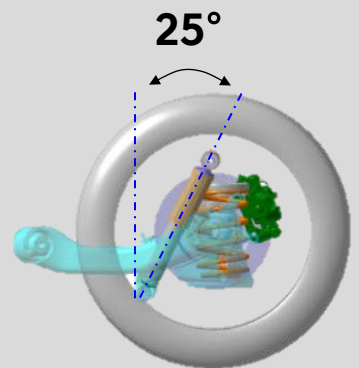
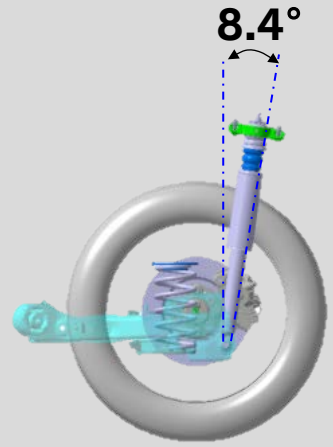
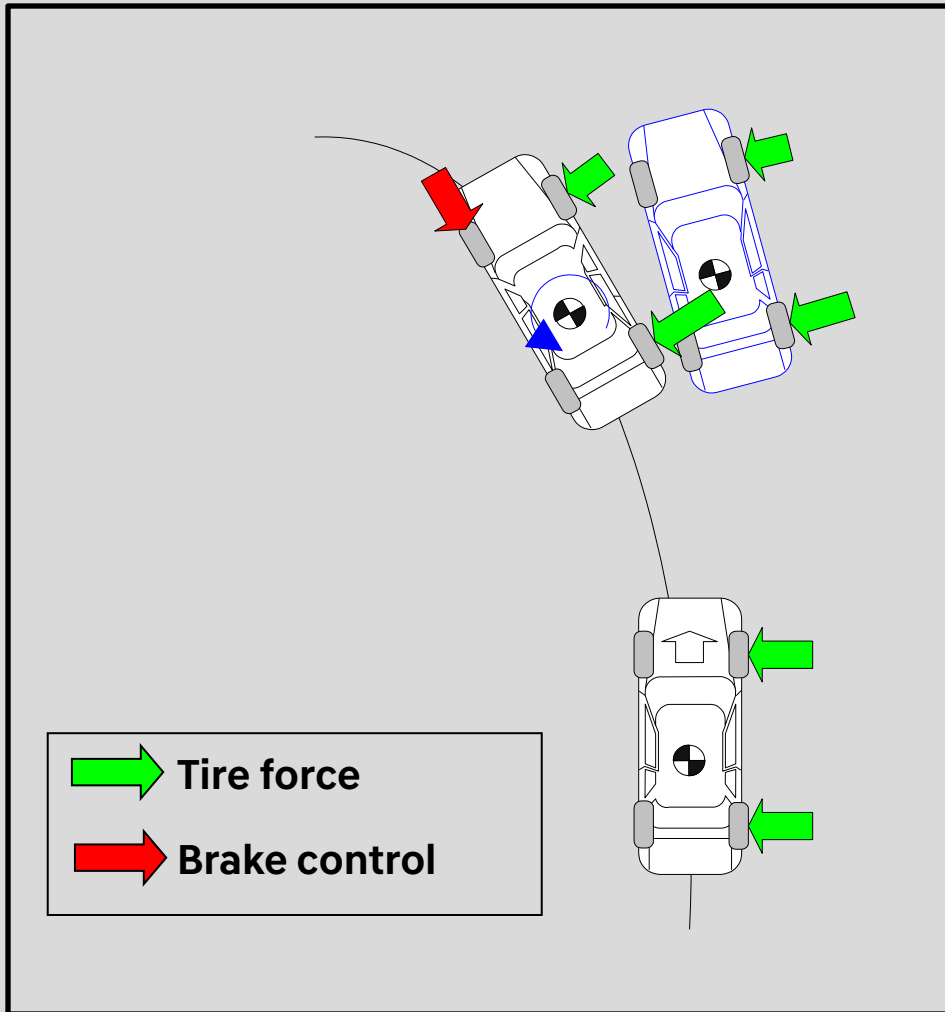

Previous Generation

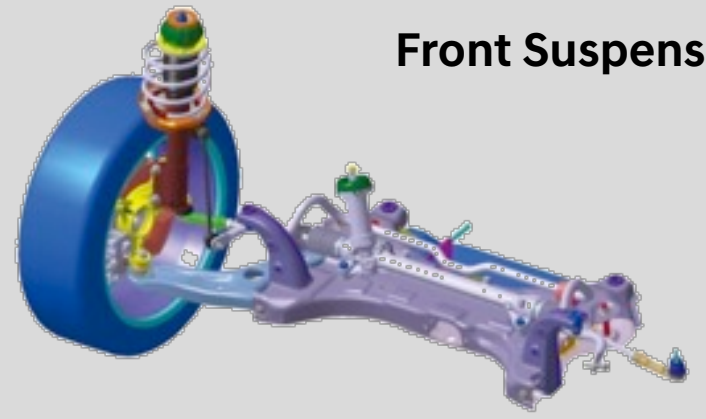

Front Suspension

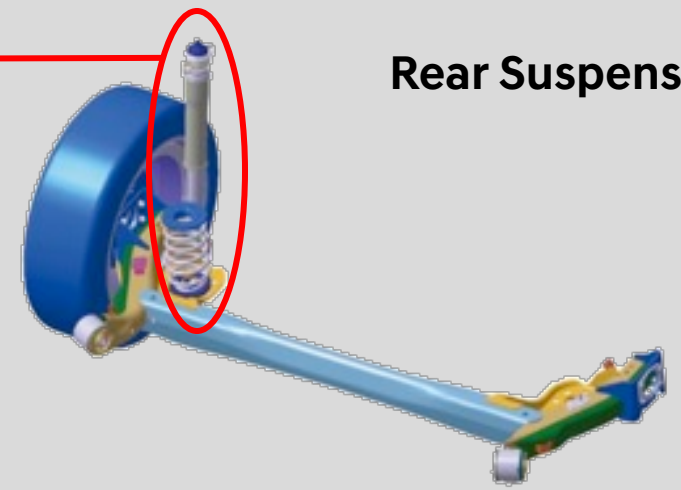

Rear Suspension

NOISE, VIBRATION AND HARSHNESS

Subframe Stiffness Improvement

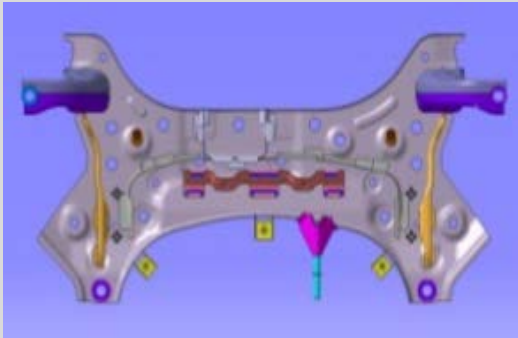

Body Cavity Blocking

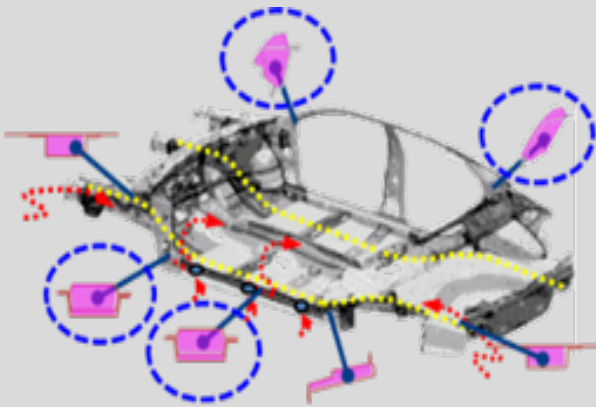

Previous generation
(Inner only)



Current generation
(Inner & outer)

| | Previous Accent | 2018 Accent | Versa | Fiesta |
|-----------------|-----------------|-------------|-------|--------|
| Road Noise (dB) | 67 | 66 | 67 | 67 |
| Wind Noise (dB) | 65 | 65 | 69 | 65 |

Improved Door Sealing

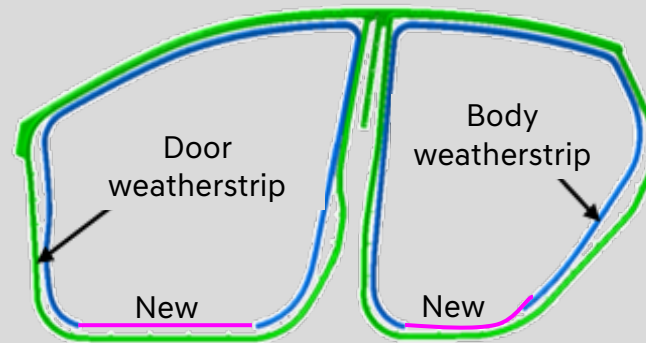

2018 ACCENT TRIM LEVELS

SE

Core entry model

- 5" Color Touchscreen with Rearview Camera
- Steering Wheel Audio & Cruise Controls
- Bluetooth Hands-free Phone
- 60/40 Split Folding Rear Seat
- Temporary Spare Tire

SEL

Nicely equipped

- 7" Display Audio
- Apple CarPlay & Android Auto
- 15" Alloy Wheels
- Automatic Headlamp Control
- Dual Charging USB
- 4-wheel Disc Brakes

Limited

Highest-equipped

- Forward Collision-avoidance Assist
- Power sunroof
- 17" Alloy Wheels
- Proximity Key with Push Button Start
- Heated Front Seats
- Blue Link Connected Services 3-year included

2018 ACCENT EXTERIOR & INTERIOR COLORS

| | | |
|---|--------------------------|-----------------|
|  | Absolute Black | Pearl |
|  | Frost White Pearl | Pearl |
|  | Olympus Silver | Metallic |
|  | Admiral Blue | Pearl |
|  | Urban Gray | Metallic |
|  | Pomegranate Red | Metallic |
|  | Linen Beige | Metallic |

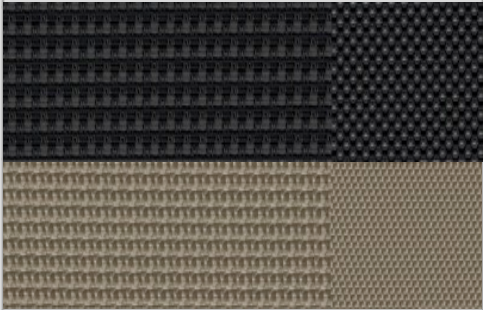
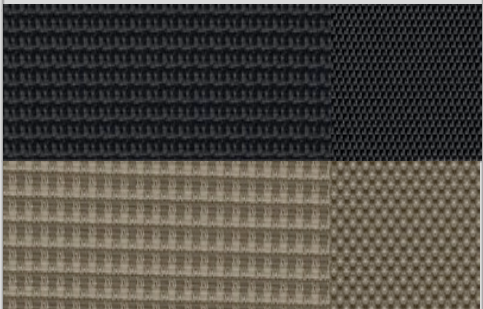
| |
|--|
| SE & SEL |
|  |
| Limited |
|  |

ACCENT PRICING BY TRIM

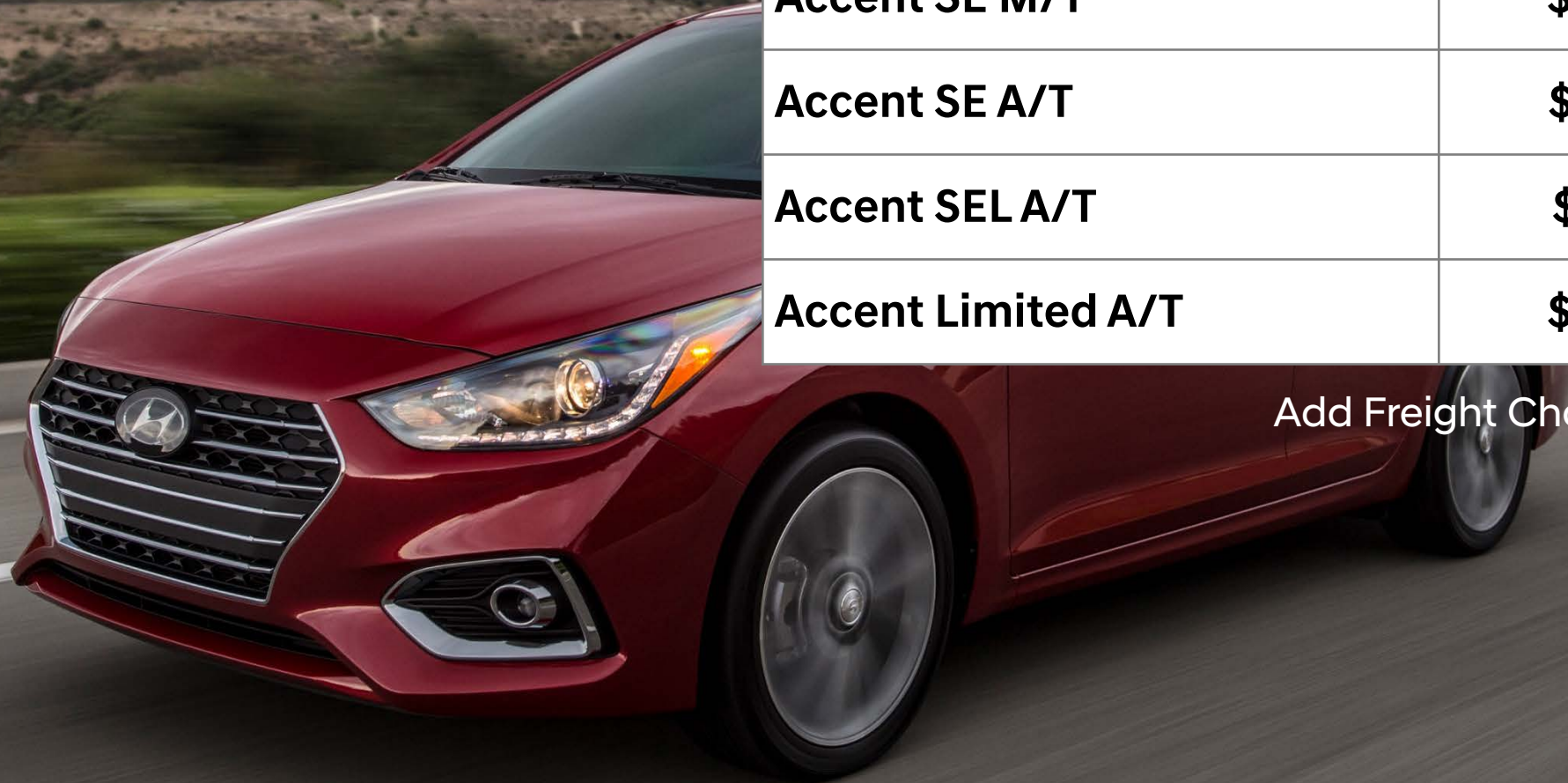

| Trim | MSRP |
|--------------------|----------|
| Accent SE M/T | \$14,995 |
| Accent SE A/T | \$15,995 |
| Accent SEL A/T | \$17,295 |
| Accent Limited A/T | \$18,895 |

Add Freight Charge: \$885

2018 ACCENT

Sophisticated Design

Advanced
Technologies

Improved Driving
Dynamics

America's Best
Warranty

Starts at \$14,995



